

FAST HIGH VOLTAGE TRANSISTOR SWITCHES

These MOSFET switches are designed for general high voltage switching applications such as pockels cell drivers, deflection and acceleration grid drivers, piezo drivers and MCP/SEV pulsers. The switching modules incorporate all features of the well known HTS switch family: Easy handling, high reliability, low jitter and reproducible switching behaviour.

Due to its very low coupling capacitance (switch against control) the series HTS-LC is preferred especially in applications with higher operating frequencies and in case of increased EMC requirements. HTS-LC switches provide significant advantages regarding noise immunity especially at high dv/dt's and may simplify critical circuit designs under EMC and EMI aspects. But for technical reasons there are some limitations in application circuits with HV transients to be expected across an opened switch (e.g. in push-pull circuits with two or more switches). Please consult factory in such cases.

The controlled turn-on will be achieved by a positive going signal of 3 to 10 volts amplitude, provided the switch is permanently connected to the +5.00 VDC auxiliary supply. The on-time may simply be varied between 200 ns and infinity by the input control pulse width. An interference-proof driver circuit provides signal conditioning, auxiliary voltage monitoring, frequency limitation and temperature protection. In case of any false operating condition the switches turn off immediately and a fault signal is generated (TTL level). The high frequency burst operation (>10 pulses/100µs) requires option 01 (external buffer capacitors). Due to the high galvanic isolation the switches may simply be operated also in floating circuits or high-side switching applications. Several housing options are available to meet individual requirements. The standard plastic case with pigtailed is the cost-effective package in low frequency applications with low average power dissipation. The plastic modules can additionally be fitted with non-isolated cooling fins (option 04), which improve the max. continuous power dissipation Pd(max) by approx. the factor 10 with forced air (>4m/s) or up to the factor 50 in oil (e.g. Silicone oil AK50 @ 50°C, flow rate >0.1m/s). With option 06 the modules can be installed also on a printed circuit board, provided additional insulation measures are taken (silicone rubber sealant or oil immersion). Potential free metal housings for a Pd(max) of 1-2 kW are available as option 05 (cf. separate data sheet "High Power Metal Case"). For detailed design recommendations please refer to the general instructions.

HTS 331-03-LC 33 kV / 30A
HTS 501-03-LC 50 kV / 30A
HTS 651-03-LC 65 kV / 30A

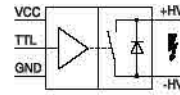

HTS 331-03-LC (Standard)

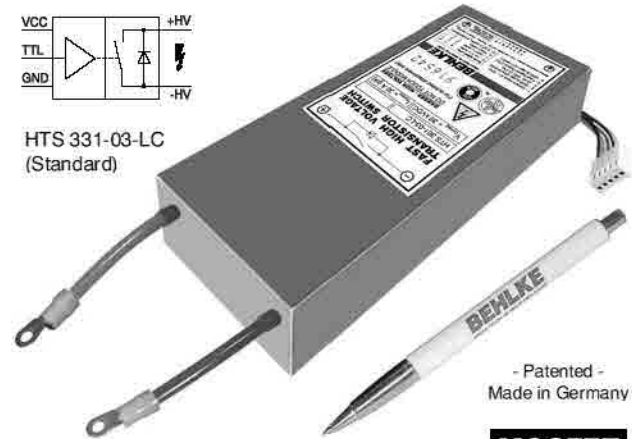

- Patented -
Made in Germany

MOSFET TECHNOLOGY

Variable On-Time
Low Coupling Capacitance
Very Compact & Light Weight

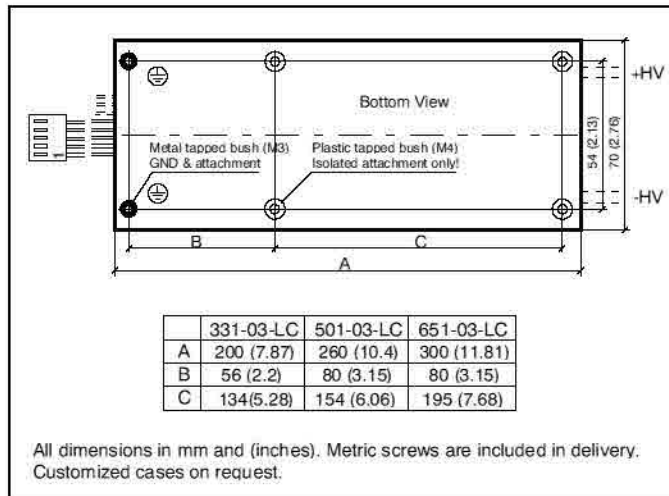

Test Circuit (High-Side Switch)

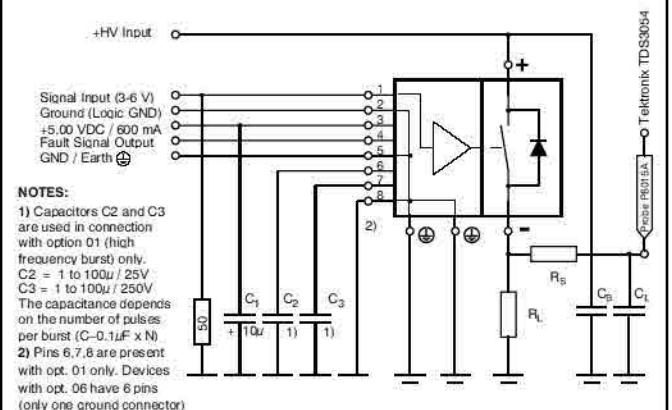

Basic Circuits

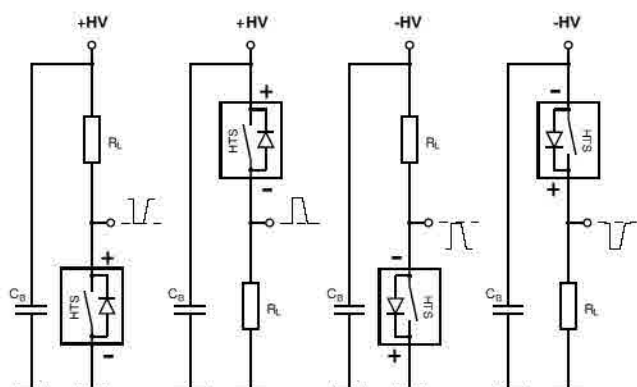

Floating Pulser

V1 must not exceed the Maximum Isolation voltage of the switching module. An OVP is recommended for V1 > Vo(max).

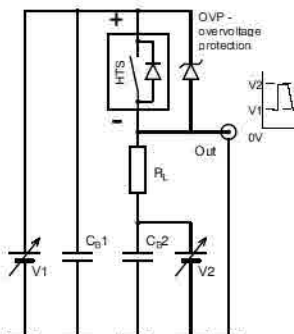

EMC / EMI Design Hints

- Always keep wiring as short as possible
- Avoid induction loops. Peak current carrying forward and return lines should be close together to minimize magnetic fields. Use coaxial lines or apply groundplane designs whenever possible.
- Use shielded or twisted leads for the control connection to minimize noise induction.
- Use low inductance part components only
- Do not "mix" the wiring of the load and the control circuit. Please note the separate wiring areas of logic and HV wiring:

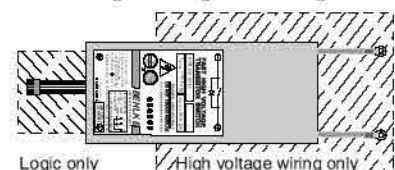

High Voltage Products. High Voltage Experts.

HVP High Voltage Products GmbH Bunsenstr. 5 82152 Martinsried/Planegg +49 89 891 374 80

www.hvproducts.de
info@hvproducts.de



TECHNICAL DATA

Specification	Symbol	Condition / Comment	331-03-LC	501-03-LC	651-03-LC	Unit
Maximum Operating Voltage	$V_{O(max)}$	$I_{off} < 10 \cdot ADC$	33	50	65	kVDC
Minimum Operating Voltage	$V_{O(min)}$	Increased $t_{r(on)}$ and $t_{r(off)}$ below $0.1 \times V_{O(max)}$		0		kVDC
Typical Breakdown Voltage	V_{br}	$I_{off} > 1 \text{ mADC}$, $T_{case} = 70^\circ\text{C}$	36	56	72	kVDC
Galvanic Isolation	V_I	Continuously	50	80	80	kVDC
Maximum Peak Current	$I_{P(max)}$	$T_{case} = 25^\circ\text{C}$ $T_{fin} = 70^\circ\text{C}$ (In oil also)	$t_p < 10 \mu\text{s}$, duty cycle $< 1\%$ $t_p < 100 \mu\text{s}$, duty cycle $< 1\%$ $t_p < 1 \text{ ms}$, duty cycle $< 1\%$	30 24 17		ADC
Max. Continuous Load Current	I_L	$T_{case} = 25^\circ\text{C}$ $T_{fin} = 70^\circ\text{C}$ (In oil also)	Standard plastic case Opt. 04, cooling fins (Air $> 4 \text{ m/s}$) Opt. 04, cooling fins (Oil $> 0.1 \text{ m/s}$)	0.33 0.94 3.22		ADC
Static On-Resistance	R_{stat}	$T_{case} = 25^\circ\text{C}$	$0.1 \times I_{P(max)}$ $1.0 \times I_{P(max)}$	72 180	112 280	144 360
Maximum Off-State Current	I_{off}	$0.8 \times V_O$, $T_{case} = 25 \dots 70^\circ\text{C}$		5		ADC
Turn-On Delay Time	$t_{d(on)}$	@ $I_{P(max)}$	150	170	180	ns
Typical Turn-On Rise Time	$t_{r(on)}$	$0.8 \times V_O$, $0.1 \times I_{P(max)}$	15	25	30	ns
Typ. Turn-Off Rise Time (Current)	$t_{r(off)}$	$0.8 \times V_O$, $0.1 \times I_{P(max)}$, resistive load, 10-90%		10		ns
Minimum On-Time	$t_{on(min)}$	Limited by driver circuit		200		ns
Maximum On-Time	$t_{on(max)}$	Please note possible $P_{d(max)}$ limitations		∞		
Switch Recovery Time	t_{rc}	t_{rc} = minimum pulse spacing		500		ns
Typical Turn-On Jitter	$t_{j(on)}$	$V_{aux} / V_{tr} = 5.0 \text{ VDC}$, fixed switching frequency		1		ns
Max. Switching Frequency	$f_{(max)}$	Please note possible $P_{d(max)}$ limitations	5	3	2.5	kHz
Maximum Burst Frequency	$f_{b(max)}$	Use option 01 for > 10 pulses within $100 \mu\text{s}$		2		MHz
Maximum Continuous Power Dissipation	$P_{d(max)}$	$T_{case} = 25^\circ\text{C}$ $T_{fin} = 70^\circ\text{C}$ (In oil also)	Standard plastic case (Air) Opt. 04, cooling fins (Air $> 4 \text{ m/s}$) Opt. 04, cooling fins (Oil $> 0.1 \text{ m/s}$)	20 160 1900	30 250 2900	36 320 3800
Linear Derating		$T_{case} = 25^\circ\text{C}$ $T_{fin} = 70^\circ\text{C}$ (In oil also)	Standard plastic case Opt. 04, cooling fins (Air $> 4 \text{ m/s}$) Opt. 04, cooling fins (Oil $> 0.1 \text{ m/s}$)	0.44 3.55 42.22	0.66 5.55 64.44	0.8 7.11 84.44
Temperature Range	T_O	Extended temperature range on request With option 03 (Increased thermal conductivity)		-40...70 -40...85		$^\circ\text{C}$
Natural Capacitance	C_N	Capacitance between switch poles at $V_{O(max)}$	20	25	30	pF
Coupling Capacitance	C_C	HV side against control side	21	30	48	pF
Diode Reverse Recovery Time	t_{rr}	$I_F = 0.1 \times I_{P(max)}$ MOSFET parasitic diode		500		ns
Diode Forward Voltage Drop	V_F	$I_F = 0.1 \times I_{P(max)}$ MOSFET parasitic diode	27	41	53	VDC
Auxiliary Supply Voltage	V_{aux}	Stabilized to $\pm 5\%$		5.0		VDC
Auxiliary Supply Current	I_{aux}	@ f_{max}		600		mADC
Control Signal	V_{tr}	$> 3 \text{ VDC}$ recommended		2-10		VDC
Fault Signal Output		TTL compatible, short circuit proof, L=Fault		H= 4 V, L= 0.5 V		VDC
Dimensions	LxWxH	Standard plastic case Flat plastic case (Opt. 06-B) Plastic case + cooling fins	200x70x35 200x70x19 200x70x70	260x70x35 260x70x19 260x70x70	300x70x35 300x70x19 300x70x70	mm ³
Weight		Standard plastic case Flat plastic case (Opt. 06-B) Plastic case + cooling fins	700 410 920	940 564 1220	1100 660 1460	g

Ordering Informations

HTS 331-03-LC Transistor switch, 33 kVDC, 30 Amps.

HTS 501-03-LC Transistor switch, 50 kVDC, 30 Amps.

HTS 651-03-LC Transistor switch, 65 kVDC, 30 Amps.

Option 01 High frequency burst

Option 03 Increased thermal conductivity. $P_{d(max)}$ will be increased by $\sim 30\%$. Limited service possibilities in case of damaged modules!

Option 04 Cooling fins, non-isolated for air+oil. Air convection is allowed up to 20 kV. **Above 20 kV oil immersion only!**

Option 05 Metal case, potential-free (Separate data sheet on request)

Option 06 HV bottom terminals for PCB assembly. Additional insulation measures (oil immersion or silicone rubber sealant) required.

Option 06-B Module height 19 mm. Not recommended for operation in air.