

The TF series product line supports the need to make accurate measurements of high voltage power supply (HVPS) and HV system performance. Each TF series device, when coupled with a conventional meter or oscilloscope, is a stand-alone test fixture optimized for a specific HV testing function. These reduced-size HV test fixture devices are engineered to support accurate measurement of ripple, noise, pulses, absolute DC, DC stability, DC line regulation, DC load regulation, etc.

Features

- › Make accurate HV in-line measurements
- › View and measure AC ripple and noise on DC HV
- › Measure absolute HV DC to 0.25% at 25 ppm stability
- › View and measure Trise, Tfall, overshoot, and settling time
- › Measure and monitor signals from 35 Hz to 10 MHz
- › View signals from DC to 20 MHz
- › View and measure AC mV on DC kV
- › PLC analog/digital remote operation capability

Typical Applications

- › Research and development
- › Incoming inspection
- › Production testing
- › Field testing
- › Calibration

CONNECTORS

The UltraVolt® TF series models all feature dual Alden B110YX10 HV connectors. These connectors facilitate in-line measurements as well as unterminated measurements. Internal ARC limiting/softening resistors are present for safety. All TF models have the HV ground return connection isolated from the chassis ground connection by 100 kΩ and clamped by a protection device.

OPERATING PERFORMANCE

The TF series operating performance is guaranteed between sea level and 10,000' in non-condensing relative humidity up to 95%, and between temperatures of -40 to +65°C (-40 to +149°F). Storage temperature range is -55 to +105°C (-67 to +221°F).

PRECISION DIVIDER: 40TF-DCD

A 40 kV rated HV test fixture that features a precision 10,000:1 DC divider (DCD) with a full scale accuracy of ±1%, a temperature stability of better than ±25 ppm per °C, and a voltage coefficient of < 1% per 40,000 V. DC loading is 1 GΩ. Capacitive loading is < 10 pF.

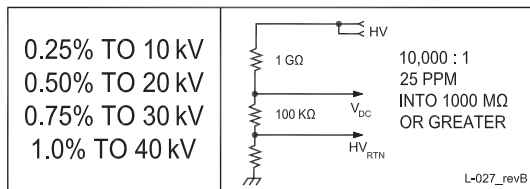

Fig. A - Accuracy and equivalent circuit (precision divider)

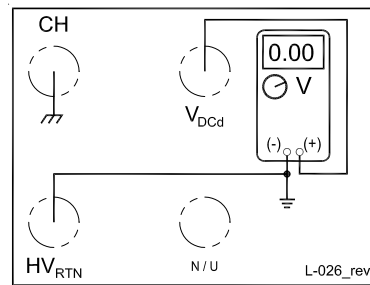

Fig. B - Electrical connections (precision divider)



A SHOCK HAZARD EXISTS WHEN THE CHASSIS GROUND OR THE HV RETURN GROUND IS NOT PROPERLY CONNECTED!

WARNING!

Note: All specifications are subject to change without notice. Advanced Energy will enhance specifications whenever possible, through continuous product and process improvement efforts. Customers are not contacted when changes are made unless they have arranged for configuration control with Advanced Energy through the "-Q" suffix program. Only the most significant items will be noted on advanced-energy.com, in the product change notice section.

RIPPLE AND VOLTAGE MONITOR: 40TF-ACV AND DCD

A 40 kV rated HV test fixture that features a 1:1 AC viewing (ACV) capacitor (VAC = 95% of VAC input $\pm 5\%$) providing a bandwidth of 35 Hz to 10 MHz (monitor 10 Hz to 20 MHz) over a signal range of 1 mV to 75 V peak, along with a 1000:1 DC divider (DCD) with a full scale accuracy of $\pm 2\%$ and a temperature stability of better than ± 100 ppm per $^{\circ}\text{C}$. DC loading is $3\text{ G}\Omega$. Capacitive loading is $< 50\text{ pF}$.

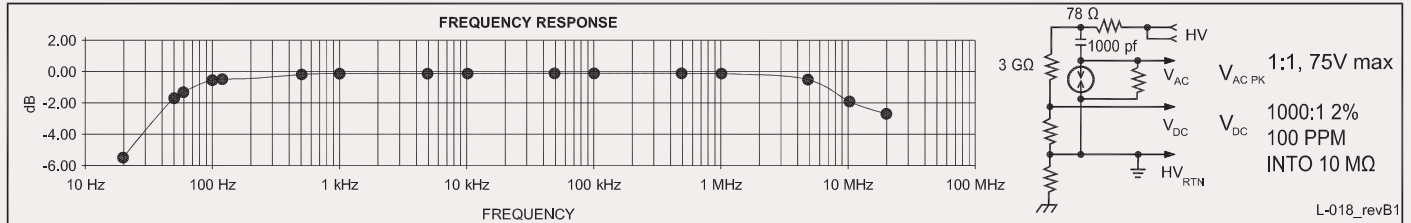

Fig. C - Bandwidth and equivalent circuit (ripple and voltage monitor)

Note: It is recommended that the oscilloscope be set for 20 MHz bandwidth limit.

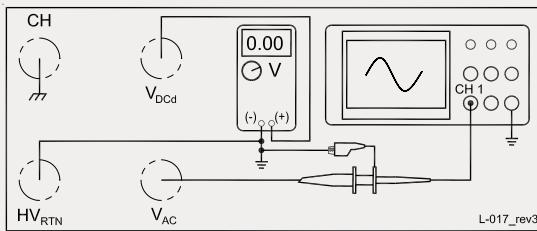

Fig. D - Electrical connections (ripple and voltage monitor)

WARNING! A SHOCK HAZARD EXISTS WHEN THE CHASSIS GROUND OR THE HV RETURN GROUND IS NOT PROPERLY CONNECTED!

COMPENSATED DIVIDER: 40TF-CDCD AND CLOAD

A 40 kV rated HV test fixture that features a compensated 1000:1 compensated DC divider (CDCD) capable of showing Trise, Tfall, overshoot and settling over a bandwidth of DC to 2 MHz. The unit also functions as a 300 pF capacitive load (CLOAD). DC loading is $1\text{ G}\Omega$. DC full scale accuracy is $\pm 2\%$ with temperature stability of better than ± 100 ppm per $^{\circ}\text{C}$.

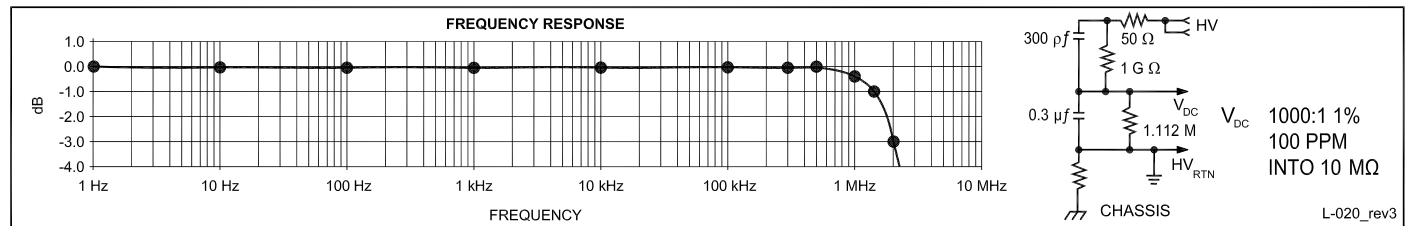

Fig. E - Bandwidth and equivalent circuit (compensated divider)

Note: It is recommended that the oscilloscope be set for 20 MHz bandwidth limit.

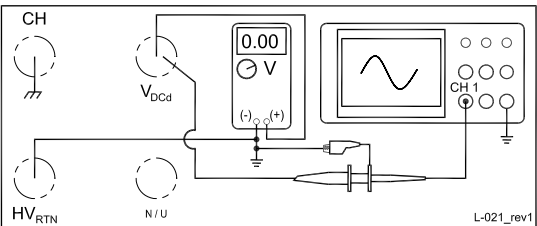
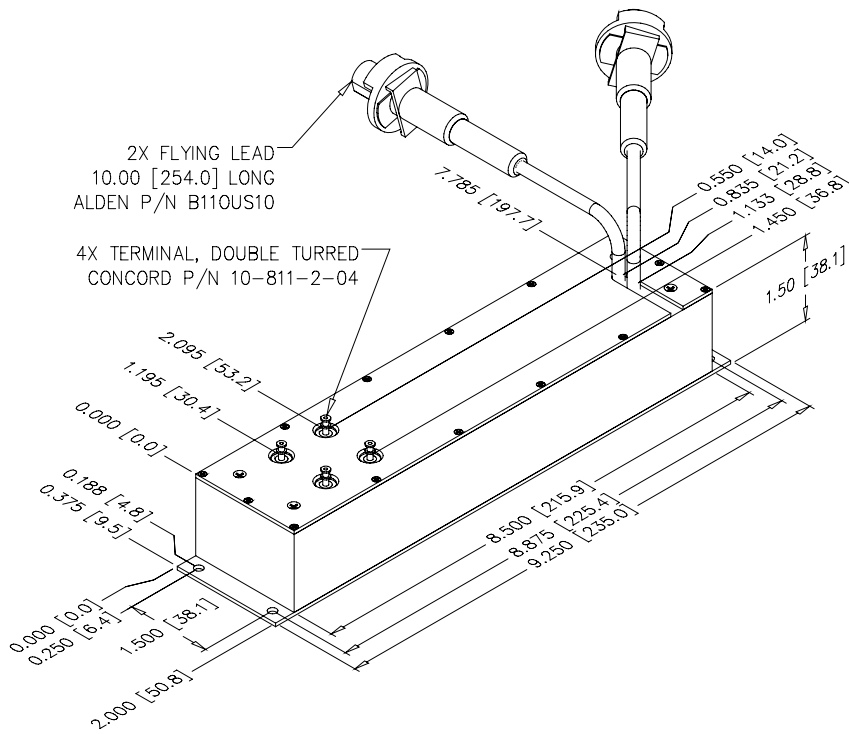

Fig. F - Electrical connections (compensated divider)

WARNING! A SHOCK HAZARD EXISTS WHEN THE CHASSIS GROUND OR THE HV RETURN GROUND IS NOT PROPERLY CONNECTED!



Note: Downloadable drawings (complete with mounting and pin information) and 3D models are available online.

PHYSICAL SPECIFICATIONS

Construction	Aluminum box anodize gold
Volume	454.74 cc (27.75 in ³)
Weight	748.43 g (1.65 lb)
Tolerance	
Overall	1.27 mm (0.050")
Pin to Pin	0.38 mm (0.015")

ORDERING INFORMATION

Type	Description
40TF-DCD	Precision divider
40TF-ACV and DCD	Ripple and voltage monitor
40TF-CDCD and CLOAD	Compensated divider

Popular accessories ordered with this product include our full range of high voltage output connectors (see Accessories and Connectors datasheet).



For international contact information, visit advanced-energy.com.



Non-RoHS compliant units are available. Please contact the factory for more information.



High Voltage Products. High Voltage Experts.

www.hvproducts.de
info@hvproducts.de

HVP High Voltage Products GmbH Bunsenstr. 5 82152 Martinsried/Planegg +49 89 8646 677-0

ENG-HV-TFseries-230-K 6.16