

# FAST HIGH VOLTAGE TRANSISTOR SWITCHES

## Description

The solid-state switch HTS 150 generates precise high-voltage pulses with amplitudes of up to 15 kV as needed for example in pulsed electrostatic deflection and acceleration systems. The HTS 150 is a cost-effective solution in all pulse applications, which require a fast leading edge and a low pulse droop at a relatively uncritical trailing edge. In contrast to conventional high-voltage switches like gas discharge tubes or electron tubes the HTS 150 does not need heating power or a complex drive circuitry. Further advantages are very short recovery times, low jitter and a lifetime typical of semiconductor devices. The power part of switch is made up of a large number of MOSFET connected in parallel and in series which are controlled absolutely synchronously. Due to the galvanic isolation the HTS 150 can be used as high-side switch for positive as well as for negative voltages. The device is protected from thermal overload by means of an internal temperature sensor. Further protection is afforded against too high a signal frequency, unsuitable control signals and an unsuitable auxiliary supply.

The on-time of the standard model is fixed at 150 ns. On-time extensions of 1, 10 and 100 microseconds as well as customized on-time extensions are available as built-in options. In connection with these options the switch can also be re-triggered according to its burst capability which allows an on-time variation in certain limits. The turn-off rise time of switches with on-time option roughly corresponds to the preceding on-time. As a result of that considerable switching losses may arise, especially at low load resistances. Therefore the working resistor should not be smaller than 10 k $\Omega$  if on-time options are used. For detailed design recommendations please refer to the instructions.

## HTS 150

15000 Volts / 30 Amps

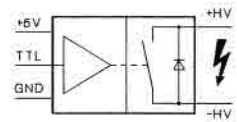

Fixed On-Time  
Simple Connection  
Compact Design

Patented

**NEW**



SPECIFICATION	SYMBOL	CONDITION / COMMENT	HTS 150	UNIT	
Maximum Operating Voltage	$V_{O(max)}$		$\pm 15000$	VDC	
Switch Breakdown Voltage <sup>1</sup>	$V_{br}$	$I_{off} = 1 \text{ mADC}$ , $T_{case} = 70^\circ\text{C}$	$> 18000$	VDC	
Isolation Voltage	$V_I$	HV side against control side	$> 18000$	VDC	
Maximum Peak Current	$I_{P(max)}$	$t_p < 10 \mu\text{s}$ , duty cycle $< 1\%$	30	ADC	
Static On-Resistance	$R_{stat}$	$I_L = 0.1 \times I_{P(max)}$	36	$\Omega$	
		$I_L = I_{P(max)}$	90		
Maximum Off-State Current	$I_{off}$	$0.8 \times V_O$	$< 15$	$\mu\text{ADC}$	
Turn-On Delay Time	$t_{d(on)}$	$0.8 \times V_O$ , $C_L = 20 \text{ pF}$ , $R_S = 51\Omega$	75	ns	
Turn-On Rise Time	$t_{r(on)}$	$R_L = 10\text{K}$	12	ns	
		$R_S = 51\Omega$	35		
			70		
Typical Turn-On Jitter	$t_{i(on)}$	$V_{aux} = 5.0 \text{ VDC}$ , $V_{tr} = 5\text{VDC}$ , $f = 1\text{kHz}$	100	ps	
On-Time	$t_{on}$	Tolerance $\pm 10\%$	Standard	150	$\mu\text{s}$
		Tolerance -10, +30%	Option 01	1	
		$t_{r(off)}$ roughly corresponds to $t_{on}$	Option 02	10	
			Option 03	100	
Maximum Burst Frequency	$f_{b(max)}$	Use burst option for $> 20$ pulses / $20\mu\text{s}$ burst	2	MHz	
Maximum Continuous Frequency	$f_{c(max)}$	@ $V_{aux} = 5.00 \text{ VDC}$ , note $P_{d(max)}$ limitations	30	kHZ	
Continuous Power Dissipation	$P_{d(max)}$	$T_{case} = 25^\circ\text{C}$ , derating $0.22 \text{ W}/^\circ\text{C}$ above $25^\circ\text{C}$	10	Watts	
Temperature Range	$T_O$	Extended temperature range on request	-30 to +70	$^\circ\text{C}$	
Switch Natural Capacitance	$C_N$	Capacitance between switch poles at $V_{O(max)}$	16	pF	
Coupling Capacitance	$C_C$	Power side against control side	20	pF	
Diode Reverse Recovery Time	$t_{rrc}$	@ $I_F = 6\text{A}$ , Caution: Diode must not be used!	1	$\mu\text{s}$	
Auxiliary Supply Voltage	$V_{aux}$	Stabilized to $\pm 5\%$	5	VDC	
Auxiliary Supply Current	$I_{aux}$	@ $f_{c(max)}$	400	mADC	
Trigger Voltage	$V_{tr}$		2-10	VDC	
Dimensions		Case only, see drawing	89x64x27	mm <sup>3</sup>	
Weight			250	g	

**BEHLKE**

## Basic Circuits

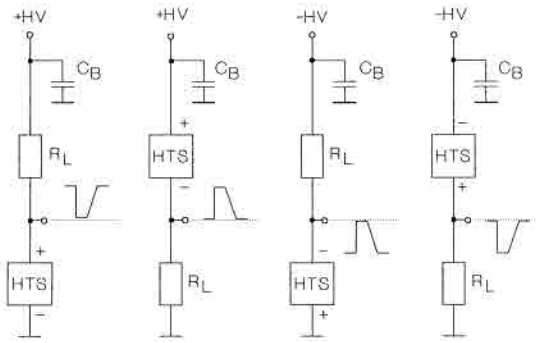

## Test Circuit (High-Side Switch)

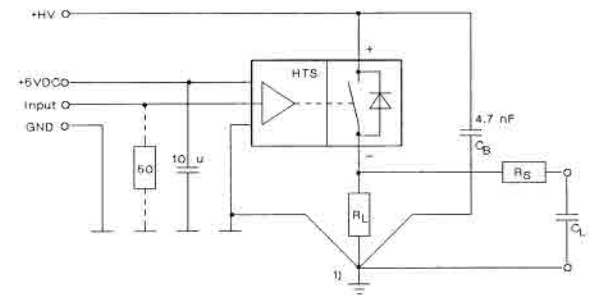

1) Star-type grounding at earth terminal  
All leads as short as possible

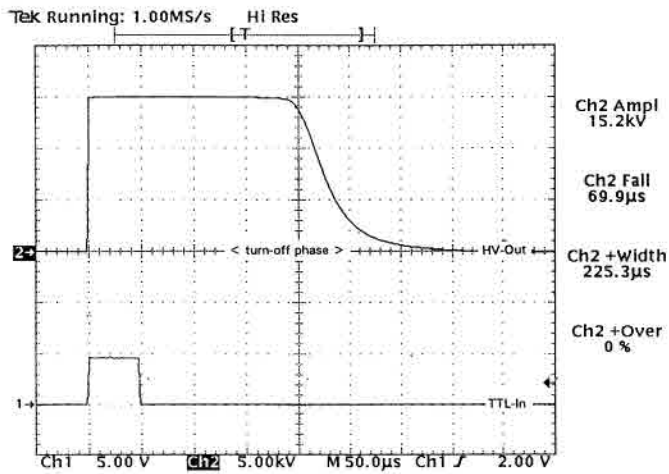

HTS 150 with 100µs on-time extension.  $R_L = 1\text{M}\Omega$ ,  $C_L = 20\text{pF}$ , vert. 5kV/div.

## Ordering Information

- HTS 150** Fast solid-state switch, 15 kVDC
- Option 01** On-time extension, 1 µs
- Option 02** On-time extension, 10 µs
- Option 03** On-time extension, 100 µs
- Option 04** Customized on-time extension
- Option 05** High frequency burst (ext. buffer caps.)
- Option 06** Flame-retardant casting resin, UL94-V0
- Option 07** Increased thermal conductivity
- Option 08** Hermetically sealed metal case for high power applications (from 11/94)
- Option 09** Soldering pins for printed circuit boards

Custom designed devices on request. All data and specifications subject to change without notice.

All dimensions in mm

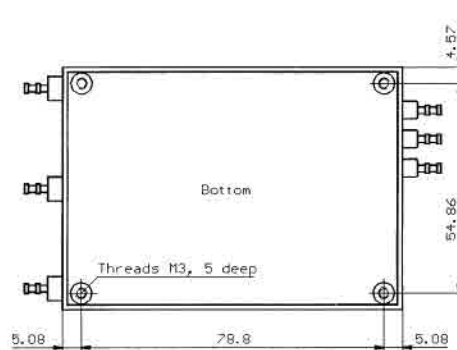

- 1 - TTL trigger input
- 2 - Return & shielding
- 3 - +5VDC / 400 mA

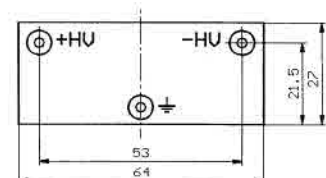
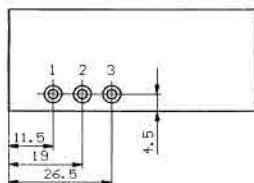

## Case HTS 150

Standard case with soldering terminals. Soldering pins for mounting on printed circuit boards are optionally available.